

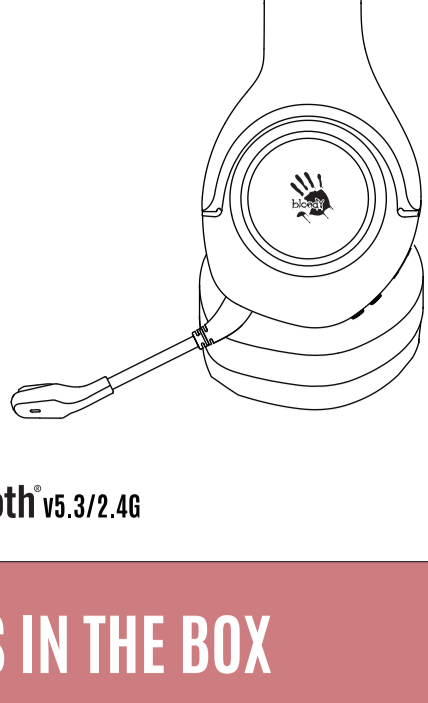

# QUICK START GUIDE



## GR270

RGB BACKLIT

2.4G + BT v5.3

SOUND EFFECT

Bluetooth v5.3/2.4G

## WHAT'S IN THE BOX

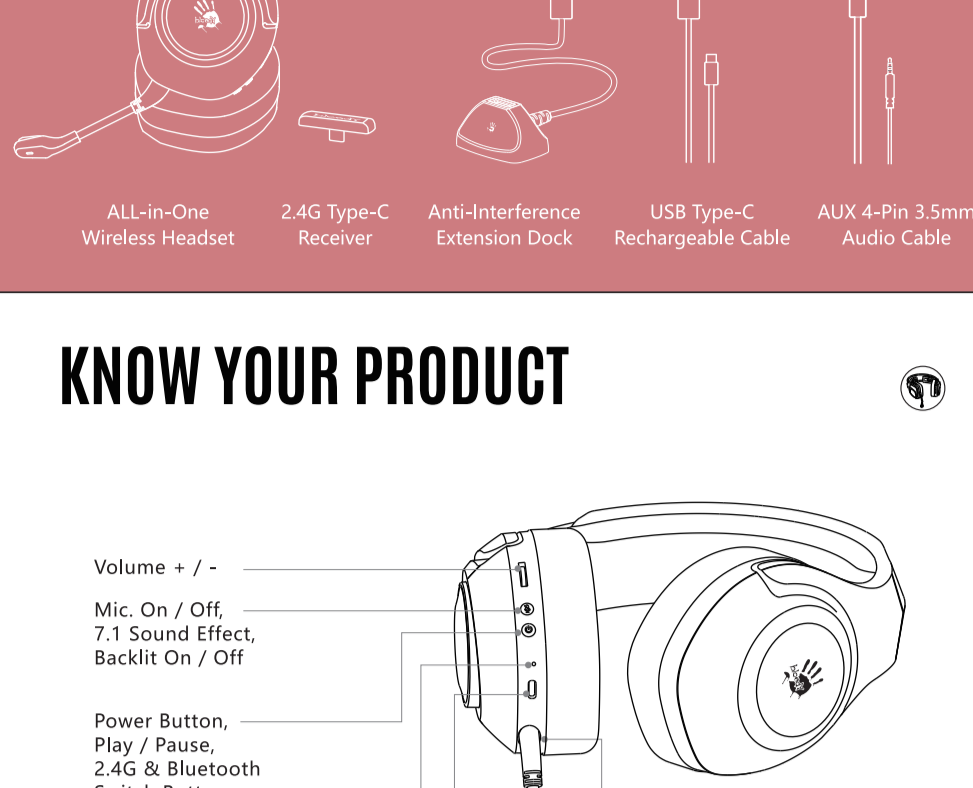

## KNOW YOUR PRODUCT



## CONTROL ON YOUR FINGERS

Note: Only for 2.4G & Bluetooth Mode

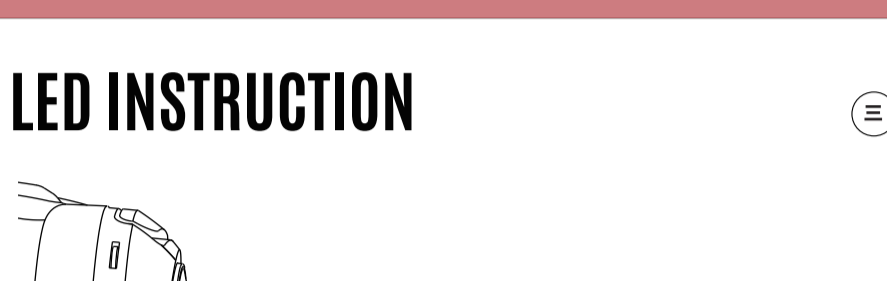

## LED INSTRUCTION

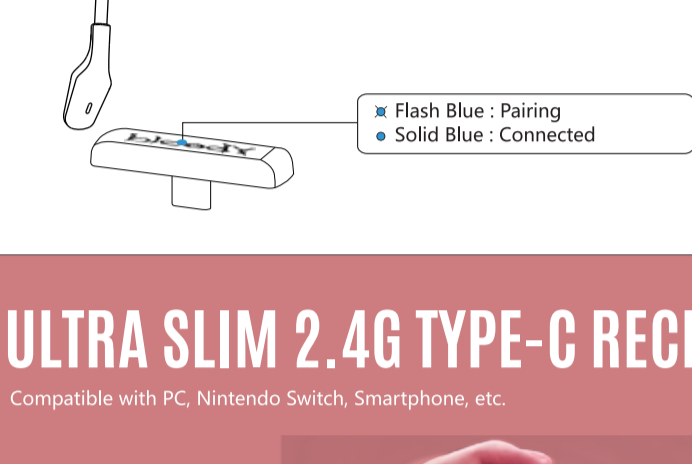

## ULTRA SLIM 2.4G TYPE-C RECEIVER

Compatible with PC, Nintendo Switch, Smartphone, etc.

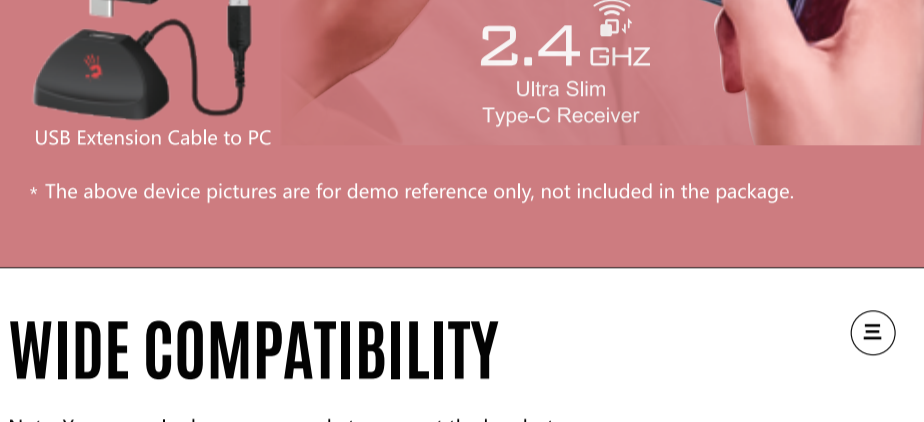

\* The above device pictures are for demo reference only, not included in the package.

## WIDE COMPATIBILITY

Note: You can only choose one mode to connect the headset. Can not operate different modes at the same time.

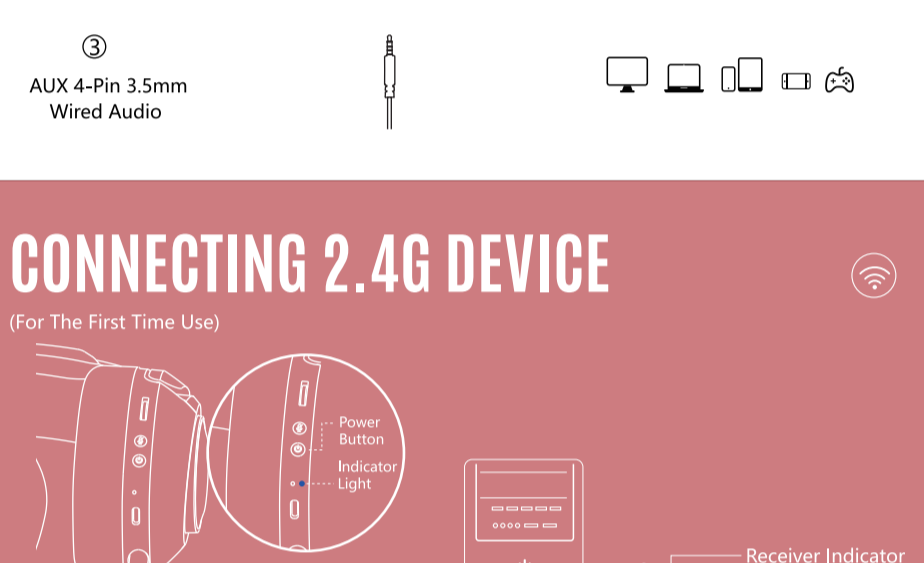

## CONNECTING 2.4G DEVICE

(For The First Time Use)

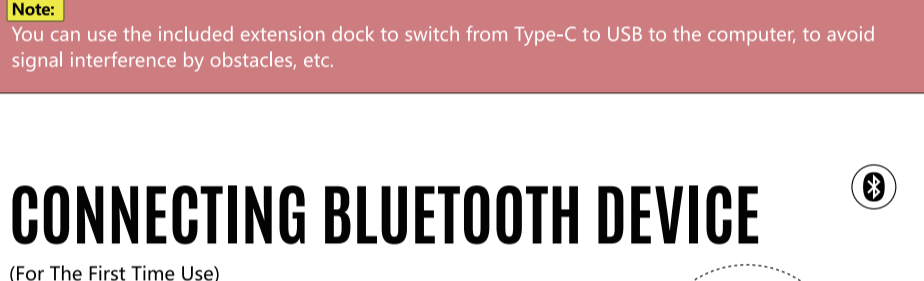

Note: You can use the included extension dock to switch from Type-C to USB to the computer, to avoid signal interference by obstacles, etc.

## CONNECTING BLUETOOTH DEVICE

(For The First Time Use)

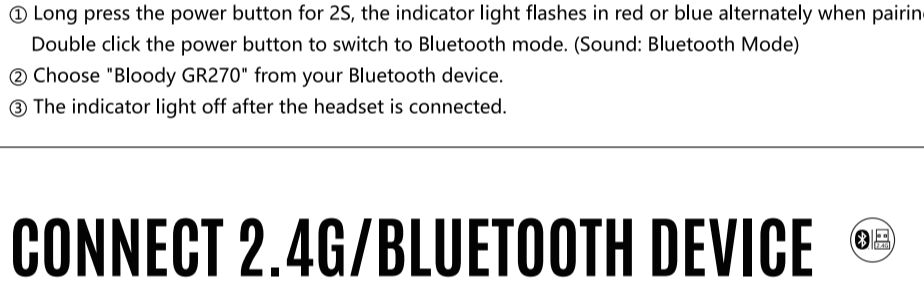

The device you connected last time will be remembered. Automatically connect back to the last device after power on.

Warm Tips: Make sure the Bluetooth devices is turned on, and the 2.4G receiver is plugged into the device.

## 2.4G/BLUETOOTH DEVICE SWITCH



Note: 1) The Bluetooth device is disconnected automatically if you switch to connect with a 2.4G device. 2) It will connect back again if you switch the headset to Bluetooth mode.

## CONNECTING WIRED DEVICES

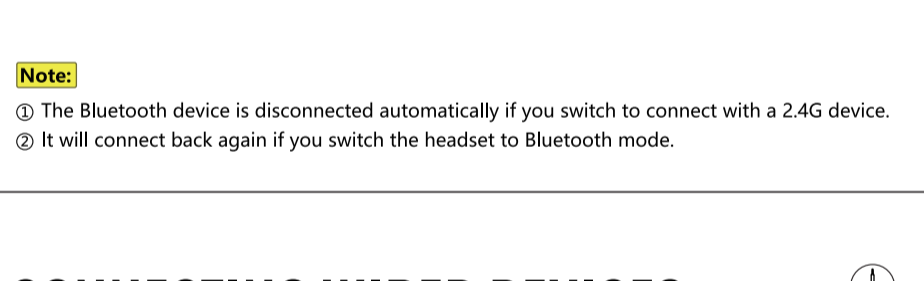

Warm Tips: Make sure the headset is power off before connect to the wired cable for original true sound.

The AUX 4-Pin 3.5mm audio cable is included. Just plug the Type-C plug into the headset and enjoy it.

## CHARGING/LOW BATTERY INDICATOR

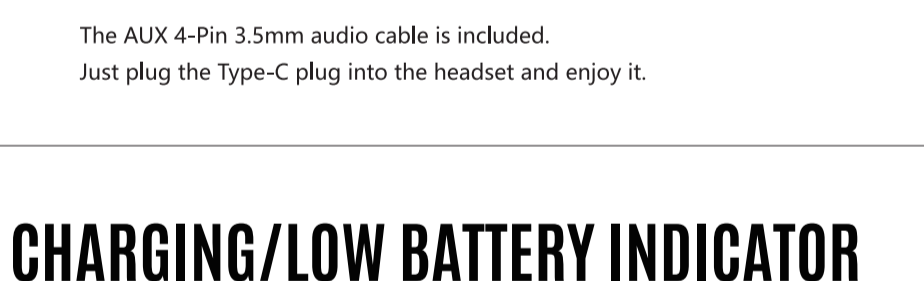

Flashing red light indicates when the battery is below 25%.

0%-15% Low Battery Notification: When the headset battery is below 15%, the headset will voice prompt "Battery Low".

## TECH SPEC

Speaker Size:	50mm
Frequency:	20Hz - 20KHz
Impedance:	16 ohm
Sensitivity:	105 dB
Mic. Type:	Unidirectional, Detachable
Mic. Frequency:	100Hz - 10KHz
Mic. Sensitivity:	-42 dB
Wired Mode:	4-Pin 3.5mm Audio
Wireless Mode:	2.4G / Bluetooth v5.3
Operation Distance:	Up to 12 m (40 feet)
Battery Type:	1050mAh Lithium Battery
Charging Time:	2.5H
Playback Time (Light Off):	60 Hours (50% volume)
(Light On):	35 Hours (50% volume)
Cable Length:	Type-C Charging Cable: 50 cm 3.5mm Audio Cable: 150 cm Extension Dock Cable: 130 cm
Weight:	327g

## SAFETY RULES

- To avoid hearing damage, do not use headphones at a high volume for a long time.
- Never disassemble or modify your headphones for any reason. Otherwise, it may cause the headphones to malfunction, which is not covered by the warranty.
- Do not get the device wet with liquids, otherwise will cause serious damage to the device. Damage caused by water entering the device will not be covered by the manufacturer's warranty.
- Please do not place the product in an environment where the temperature is too low (above 45°C or below -20°C).
- Do not place your device's light close to your eyes.
- Not suitable for children under 3 years old.
- Do not use the device during a thunderstorm.

## WARNING STATEMENT

THE FOLLOWING ACTIONS MAY DAMAGE THE PRODUCT.

- To disassemble, bump, crush, or throw into the fire is forbidden for lithium batteries.
- Do not expose under the strong sunlight.
- The discard of the battery should obey the local law, if possible please recycle it. Do not dispose of it as household garbage, because it may cause an explosion.
- Do not continue to use if severe swelling occurs.
- Please try to avoid charging in an environment below 0°C.
- The user is not allowed to remove or replace the batteries unless specified statement in the user manual.



The Bluetooth word mark and logos are registered trademarks owned by the Bluetooth SIG, Inc. and any use of such marks by Bloody is under license. Other trademarks and trade names are those of their respective owners.

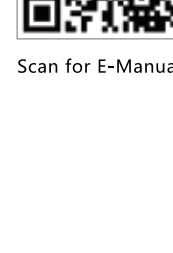

www.Bloody.com

Scan for E-Manual