

**QUICK
START
GUIDE**

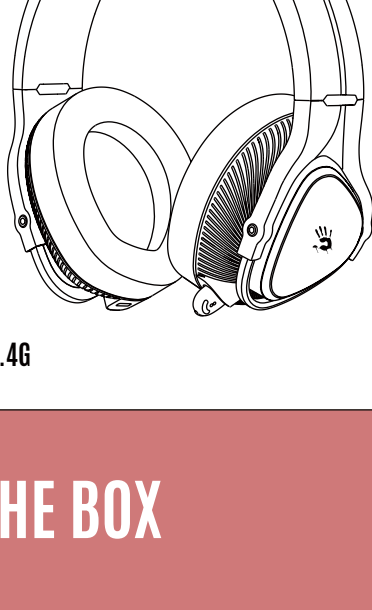

- RGB STREAMER
- 2.4G + BT v5.3
- M.O.C.I. TECH
- 65H

Bluetooth v5.3/2.4G

WHAT'S IN THE BOX



KNOW YOUR PRODUCT



CONTROL ON YOUR FINGERS

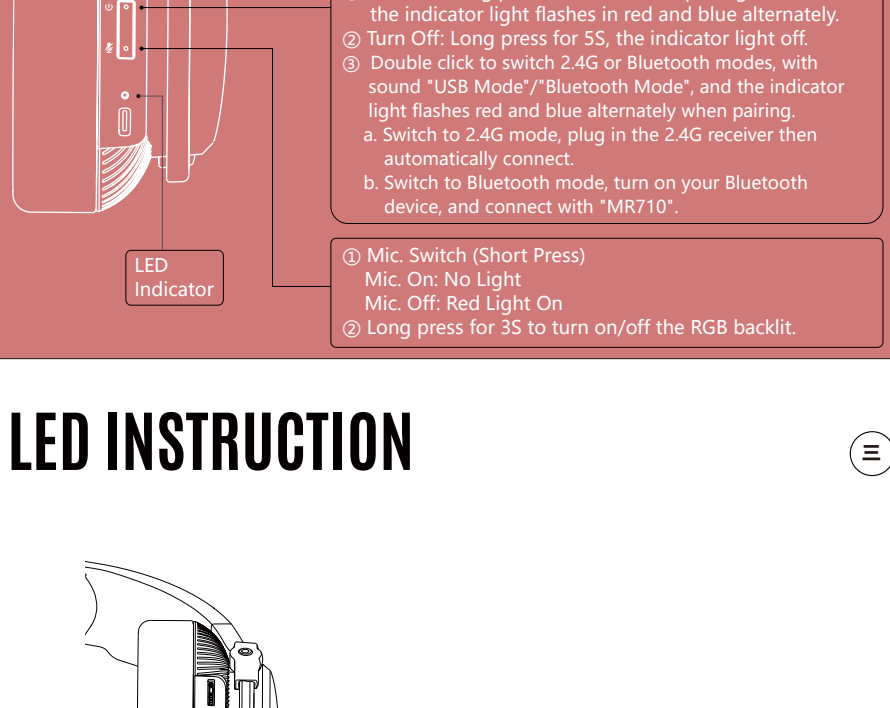

LED INSTRUCTION

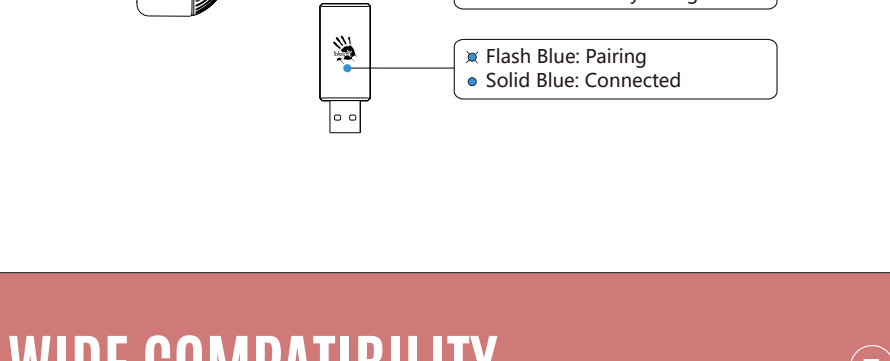

WIDE COMPATIBILITY

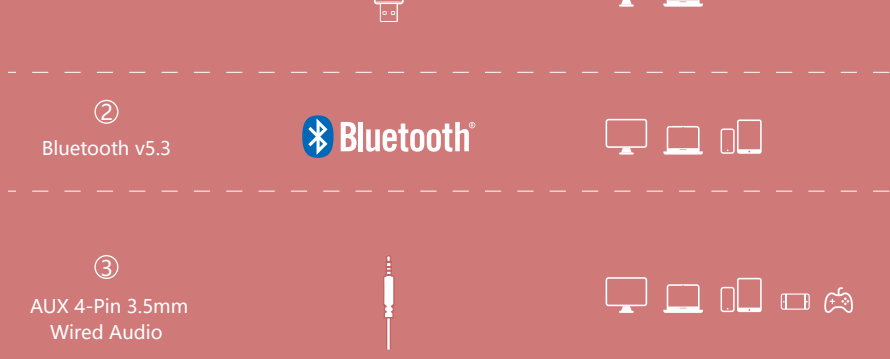

CONNECTING 2.4G DEVICE

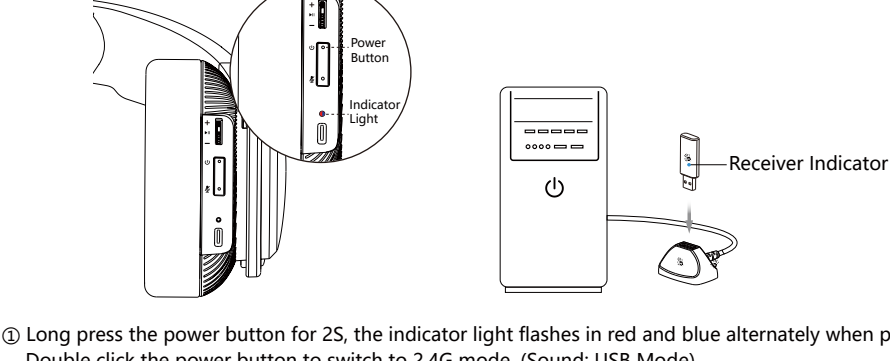

- Long press the power button for 2S, the indicator light flashes in red and blue alternately when pairing. Double click the power button to switch to 2.4G mode. (Sound: USB Mode)
- Plug in the 2.4G USB receiver to your computer.
- After connected headset, the headset indicator light off, the receiver indicator is in solid blue.

CONNECTING BLUETOOTH DEVICE

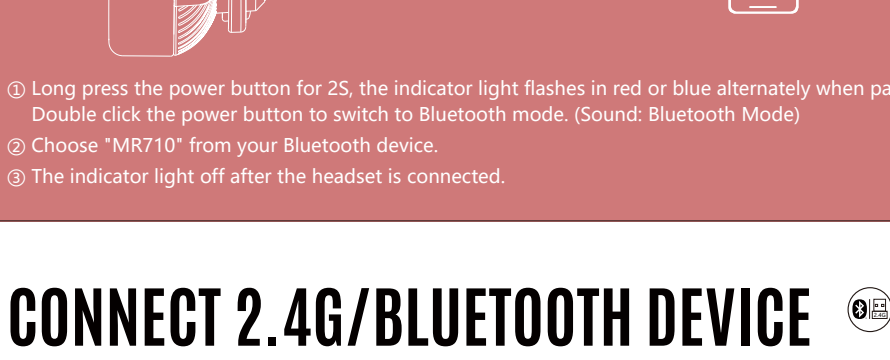

- Long press the power button for 2S, the indicator light flashes in red or blue alternately when pairing. Double click the power button to switch to Bluetooth mode. (Sound: Bluetooth Mode)
- Choose "MR710" from your Bluetooth device.
- The indicator light off after the headset is connected.

CONNECT 2.4G/BLUETOOTH DEVICE



The device you connected last time will be remembered. Automatically connect back to the last device after power on.

Warm Tips: Make sure the Bluetooth devices is turned on, and the 2.4G receiver is plugged into the device.

CONNECTING WIRED DEVICES

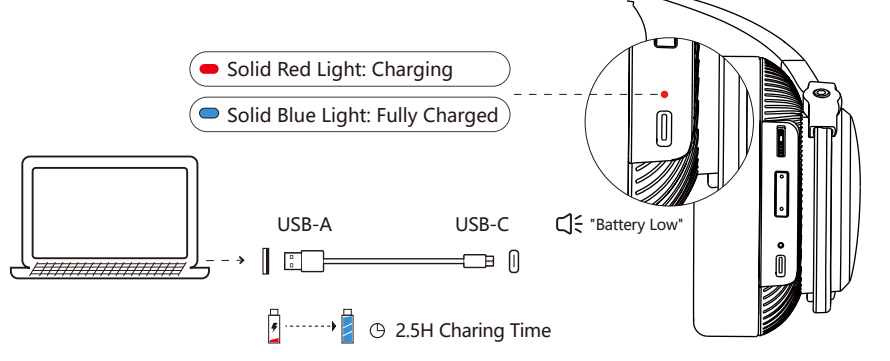

Warm Tips: Make sure the headset is power off before connect to the wired cable for original true sound.

The AUX 4-Pin 3.5mm audio cable is included. Just plug the Type-C plug into the headset and enjoy it.

CHARGING/LOW BATTERY INDICATOR

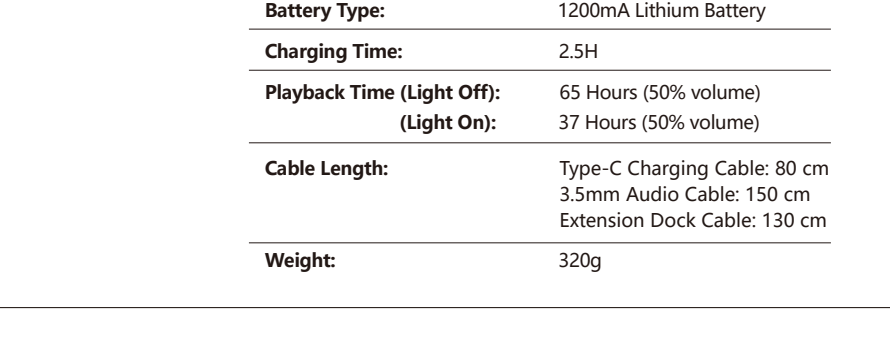

Flashing red light indicates when the battery is below 25%.

0%-15% Low Battery Notification When the headset battery is below 15%, the headset will voice prompt "Battery Low".

TECH SPEC

Speaker Size:	50mm Hybrid Diaphragm
Frequency:	20Hz - 20KHz
Impedance:	16 ohm
Sensitivity:	105 dB
Mic. Type:	Unidirectional
Mic. Frequency:	100Hz - 10KHz
Mic. Sensitivity:	-42 dB
Wired Mode:	4-Pin 3.5mm Audio
Wireless Mode:	2.4G / Bluetooth v5.3
Operation Distance:	Up to 12 m (40 feet)
Battery Type:	1200mAh Lithium Battery
Charging Time:	2.5H
Playback Time (Light Off):	65 Hours (50% volume)
(Light On):	37 Hours (50% volume)
Cable Length:	Type-C Charging Cable: 80 cm 3.5mm Audio Cable: 150 cm Extension Dock Cable: 130 cm
Weight:	320g

SAFETY RULES

- To avoid hearing damage, do not use headphones at a high volume for a long time.
- Never disassemble or modify your headphones for any reason. Otherwise, it may cause the headphones to malfunction, which is not covered by the warranty.
- Do not get the device wet with liquids, otherwise will cause serious damage to the device. Damage caused by water entering the device will not be covered by the manufacturer's warranty.
- Please do not place the product in an environment where the temperature is too low (above 45°C or below -20°C).
- Do not place your device's light close to your eyes.
- Do not suitable for children under 3 years old.
- Do not use the device during a thunderstorm.

WARNING STATEMENT

- THE FOLLOWING ACTIONS MAY DAMAGE THE PRODUCT.
- To disassemble, bump, crush, or throw into the fire is forbidden for lithium batteries.
 - Do not expose under the strong sunlight.
 - The discard of the battery should obey the local law, if possible please recycle it. Do not dispose of it as household garbage, because it may cause an explosion.
 - Do not continue to use if severe swelling occurs.
 - Please try to avoid charging in an environment below 0°C.
 - The user is not allowed to remove or replace the batteries unless specified statement in the user manual.

Bluetooth

The Bluetooth word mark and logos are registered trademarks owned by the Bluetooth SIG, Inc. and any use of such marks by Bloody is under license. Other trademarks and trade names are those of their respective owners.

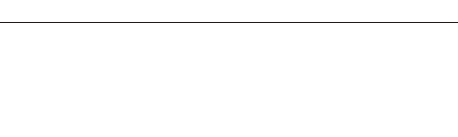

www.Bloody.com Scan for E-Manual